

MCTRL4K

LED Display Controller



User Manual

Change History

Document Version	Release Date	Description
V1.2.0	2022-04-01	<ul style="list-style-type: none">• Added the function of switching from RGB limited to RGB full.• Added the phase offset function.
V1.1.1	2020-07-18	Optimized the document content and style.
V1.1.0	2019-09-04	<ul style="list-style-type: none">• Added the 3D function.• Added the low latency function.• Added the function of individual gamma adjustment for RGB.• Added HLG mode.• Added the image settings function.• Added the function of input source bit depth settings on the control computer.• Added the function of importing custom EDID.• Added support for the 25Hz frame rate.• Added the function of adaptation to decimal frame rates.• Optimized HDR10 performance by adding low grayscale mode adjustment.• Optimized the Mapping function illustration diagram.
V1.0.0	2019-09-26	First release

Contents

1 Overview.....	1
1.1 Introduction.....	1
1.2 Features.....	1
2 Appearance.....	2
3 Applications.....	5
4 Cascade Devices.....	6
5 Home Screen.....	7
6 Menu Operations.....	9
6.1 Quick Screen Configuration.....	9
6.1.1 Step 1: Set Input Mode.....	9
6.1.2 Step 2: Set Input Resolution.....	10
6.1.3 Step 3: Quickly Configure the Screen.....	13
6.2 Brightness Adjustment.....	14
6.3 Screen Settings.....	14
6.3.1 Advanced Configuration.....	14
6.3.2 Image Offset.....	15
6.4 Display Control.....	15
6.5 Advanced Settings.....	16
6.5.1 Mapping Function.....	16
6.5.2 Load Cabinet Configuration Files.....	17
6.5.3 Set Alarm Thresholds.....	18
6.5.4 Save to Hardware.....	18
6.5.5 Redundancy Settings.....	18
6.5.6 Factory Reset.....	18
6.5.7 HDR.....	18
6.5.8 3D Settings.....	21
6.5.9 Genlock Setting.....	26
6.5.10 Hardware Version.....	26
6.6 Communication Settings.....	26
6.7 Language.....	27
7 Operations on PC.....	28
7.1 Individual Gamma Adjustment for RGB.....	28
7.2 Low Latency.....	28
7.3 Input Source Bit Depth.....	30
7.4 Operations on Web Page.....	31
7.4.1 Environment Configuration.....	32
7.4.2 Operations.....	32
7.5 Software Operations on PC.....	33
7.5.1 NovaLCT.....	33
7.5.2 SmartLCT.....	33
7.6 Firmware Update.....	33
7.6.1 NovaLCT.....	33
7.6.2 SmartLCT.....	34
8 Specifications.....	35

1 Overview

1.1 Introduction

The MCTRL4K is an LED display controller with an ultra-large loading capacity developed by NovaStar. A single unit features a loading capacity of up to 4096×2160@60Hz. It supports any custom resolutions with a width or height up to 7680 pixels, meeting the on-site configuration requirements of ultra-long or ultra-wide LED displays.

The MCTRL4K comes with many industry-leading technologies such as HDR, individual gamma adjustment for RGB, low latency, 3D, and pixel level brightness and chroma calibration. These technologies improve the display brightness, grayscale and color performance, presenting more uniform, detailed and vivid images.

The MCTRL4K is stable, reliable and powerful, dedicated to providing users with an ultimate visual experience. It can be mainly used in the rental and fixed installation applications, such as concerts, live events, security monitoring, Olympic Games, various sports centers, and much more.

1.2 Features

- A variety of input connectors
 - 1x DP 1.2
 - 1x HDMI 2.0
 - 2x DL-DVI
- 16 Neutrik Gigabit Ethernet ports and 4 optical ports

For DP/HDMI input, the maximum loading capacity is 8,800,000 pixels.

For DVI input, the maximum loading capacity is 8,300,000 pixels.

The maximum output height or width of a single MCTRL4K is 7680 pixels.
- High bit-depth inputs: 8bit/10bit/12bit
- HDR function

HDR10 and HLG are supported.

The MCTRL4K can work with the receiving cards that support HDR to greatly enhance the image quality of the display, presenting more vivid and detailed images.
- 3D function

The MCTRL4K can work with the 3D emitter EMT200 and 3D glasses, allowing you to experience 3D display effects.
- Individual gamma adjustment for RGB

For 10-bit or 12-bit inputs, this function can individually adjust the red gamma, green gamma and blue gamma to effectively control image non-uniformity in low grayscale conditions and white balance offset, allowing for a more realistic image.
- RGB limited to RGB full

This function automatically converts the color range of the input source from RGB limited to RGB full so as to display natural black in low grayscale conditions.
- Low latency

When low latency and input source sync are enabled, and cabinets are connected vertically, the delay between the input source and receiving card can be reduced to one frame.
- Inputs with decimal frame rates

Adaptive to
23.98/29.97/47.95/59.94/71.93/119.88 Hz
- Pixel level brightness and chroma calibration

The MCTRL4K can work with NovaStar's high-precision calibration system to calibrate the brightness and chroma of each pixel, effectively removing brightness differences and chroma differences, enabling high brightness consistency and chroma consistency.
- Ultra-high resolution input

Supports ultra-high resolution settings with NVIDIA graphics card.
- Screen configuration on web
- Cascading of up to 10 MCTRL4K units

2 Appearance

Front Panel



No.	Button/Connector	Description
1	Power button	Power on or off the device.
2	USB	Connect to a USB drive.
3	LCD screen	Display the device status, menus, submenus and messages.
4	Knob	Select menus, adjust parameters, and confirm operations.
5	BACK	Go back to the previous menu or exit the current operation.

Note

Hold down the knob and **Back** button simultaneously for 5s or longer to lock or unlock the front panel buttons.

Rear Panel



Connector Type	Connector Name	Description
Input	DP 1.2	<p>1x DP 1.2</p> <ul style="list-style-type: none"> Supported maximum resolution: 4096x2160@60Hz, supported minimum resolution: 640x480@24Hz Custom resolutions supported <ul style="list-style-type: none"> Maximum width: 7680 pixels (7680x1080@60Hz) Maximum height: 7680 pixels (1080x7680@60Hz) HDCP 1.3 compliant Supported standard resolutions: <ul style="list-style-type: none"> 1280x1024@(24/25/30/48/50/60/72/75/85/100/120)Hz 1366x768@(24/25/30/48/50/60/72/75/85/100/120)Hz 1440x900@(24/25/30/48/50/60/72/75/85/100/120)Hz 1600x1200@(24/25/30/48/50/60/72/75/85/100/120)Hz

		<p>1920×1080@(24/25/30/48/50/60/72/75/85/100/120)Hz 1920×1200@(24/25/30/48/50/60/72/75/85/100/120)Hz 1920×2160@(24/25/30/48/50/60/72/75/85/100/120)Hz 2560×1600@(24/25/30/48/50/60/72/75/85/100/120)Hz 3840×1080@(24/25/30/48/50/60/72/75/85/100/120)Hz 3840×2160@(24/25/30/48/50/60)Hz</p> <ul style="list-style-type: none"> • No support for interlaced input sources
	HDMI 2.0	<p>1x HDMI 2.0</p> <ul style="list-style-type: none"> • Supported maximum resolution: 4096×2160@60Hz, supported minimum resolution: 800×600@30Hz • Custom resolutions supported Maximum width: 7680 pixels (7680×1080@60Hz) Maximum height: 7680 pixels (1080×7680@60Hz) • HDCP 1.4 and HDCP 2.2 compliant • Supported standard resolutions: 1280×1024@(24/25/30/48/50/60/72/75/85/100/120)Hz 1440×900@(24/25/30/48/50/60/72/75/85/100/120)Hz 1600×1200@(24/25/30/48/50/60/72/75/85/100/120)Hz 1920×1080@(24/25/30/48/50/60/72/75/85/100/120)Hz 1920×1200@(24/25/30/48/50/60/72/75/85/100/120)Hz 1920×2160@(24/25/30/48/50/60/72/75/85/100/120)Hz 2048×1536@(24/25/30/48/50/60/72/75/85/100/120)Hz 2560×1600@(24/25/30/48/50/60/72/75/85/100/120)Hz 3840×1080@(24/25/30/48/50/60/72/75/85/100/120)Hz 3840×2160@(24/25/30/48/50/60)Hz • No support for interlaced input sources
	DUAL DVI-D1 DUAL DVI-D2	<p>2x DL-DVI</p> <ul style="list-style-type: none"> • Each with a maximum resolution of 3840×1080@60Hz and minimum resolution of 800×600@30Hz • Custom resolutions supported Maximum width: 3840 pixels (3840×1080@60Hz) Maximum height: 3840 pixels (800×3840@60Hz) • Supported standard resolutions: 1280×1024@(24/25/30/48/50/60/72/75/85/100/120)Hz 1366×768@(24/25/30/48/50/60/72/75/85/100/120)Hz 1440×900@(24/25/30/48/50/60/72/75/85/100/120)Hz 1600×1200@(24/25/30/48/50/60/72/75/85/100/120)Hz 1920×1080@(24/25/30/48/50/60/72/75/85/100/120)Hz 1920×1200@(24/25/30/48/50/60/72/75/85/100)Hz 1920×2160@(24/25/30/48/50/60)Hz 2560×1600@(24/25/30/48/50/60)Hz 3840×1080@(24/25/30/48/50/60)Hz 3840×2160@(24/25/30)Hz • No support for interlaced input sources
Output	1~16	<p>16x Neutrik (NE8FBH) Gigabit Ethernet ports</p> <ul style="list-style-type: none"> • Maximum capacity of a single port: For 8-bit input sources: 650,000 pixels For 10-bit/12-bit input sources: 320,000 pixels • No support for audio output • Support for redundancy between Ethernet ports
	OPT1~OPT4	4x 10G optical ports

		<ul style="list-style-type: none"> • OPT1 transmits the data of Ethernet ports 1 to 8. • OPT2 transmits the data of Ethernet ports 9 to 16. • OPT3 is a duplicate channel of OPT1. • OPT4 is a duplicate channel of OPT2.
Control	ETHERNET	Connect to the control computer.
	USB IN-OUT	<ul style="list-style-type: none"> • IN: 1x USB 2.0 (Type-B) Input port for cascading MCTRL4K units, or connecting to a PC for debugging • OUT: 1x USB 2.0 (Type-A) Output port for cascading MCTRL4K units Up to 10 units can be cascaded.
	GENLOCK IN-LOOP	Sync signal connector Support for Bi-level, Tri-level, and Blackburst <ul style="list-style-type: none"> • IN: Genlock input connector • LOOP: Genlock loop output connector
Power	AC 100 V~240 V-50/60 Hz	

Note

- When the input source is HDMI or DP, the 144 Hz forced resolution input from the front end device can be parsed. In this situation, the loading capacity is reduced by half.
- This product can only be placed horizontally. Do not mount vertically or upside-down.

3 Applications

The MCTRL4K can work in mosaic and multi-card modes, meeting multiple user application needs.

Application 1: Mosaic Mode

Figure 3-1 Application of mosaic mode

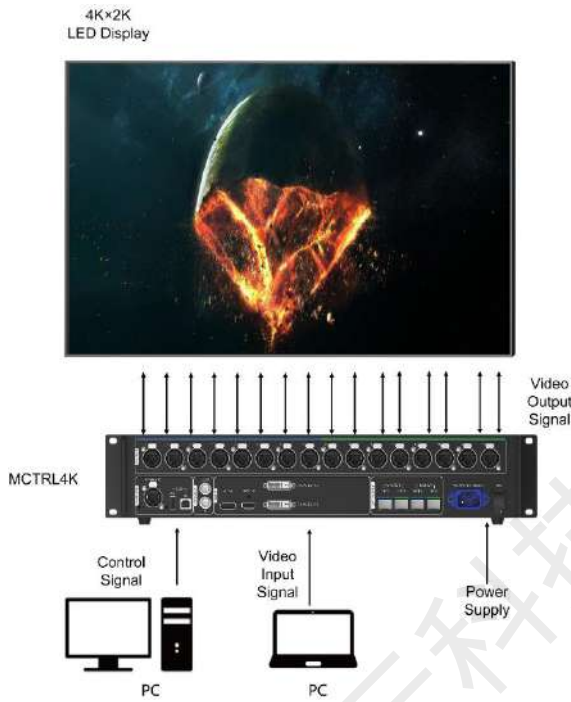

Application 2: Multi-Card Mode

Figure 3-2 Application of multi-card mode

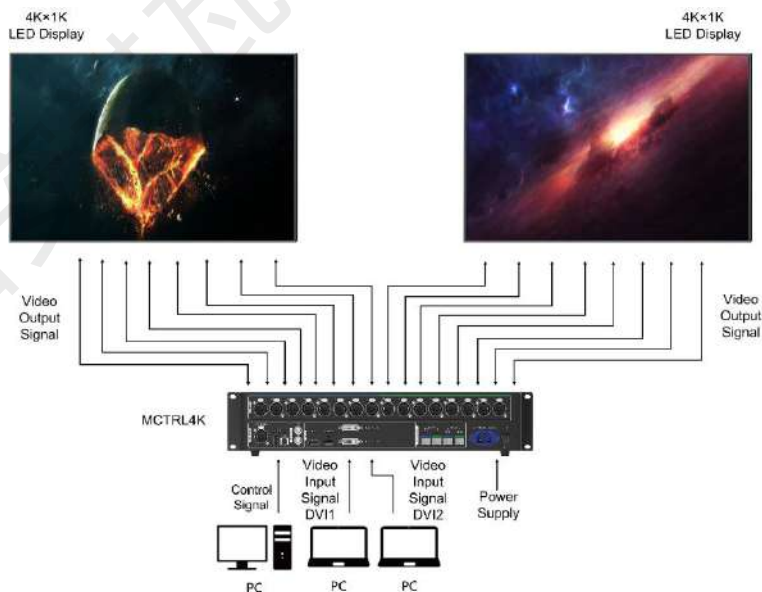

4 Cascade Devices

- The control computer controls multiple MCTRL4K devices.

Cascade the MCTRL4K devices via their USB IN and USB OUT ports. Up to 10 devices can be cascaded.

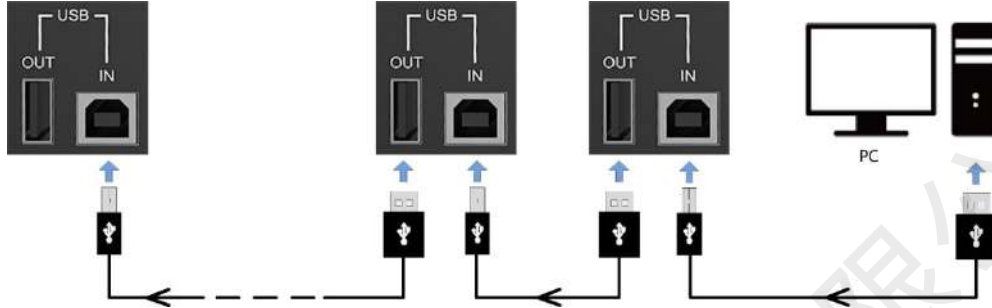

- Multiple MCTRL4K devices output image simultaneously.

Cascade the MCTRL4K devices via their GENLOCK IN and GENLOCK LOOP connectors. Up to 10 devices can be cascaded.

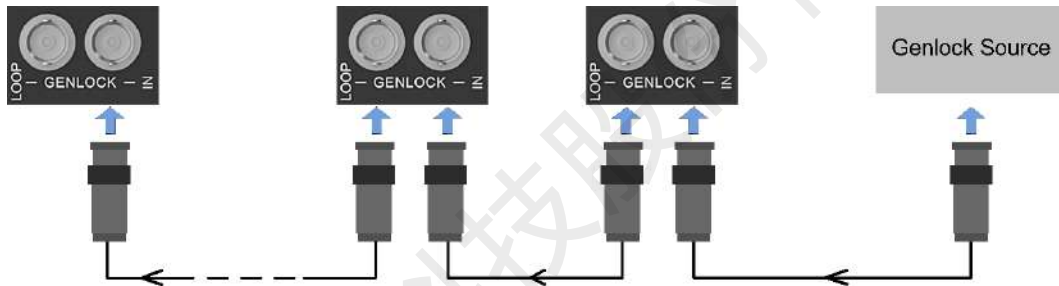







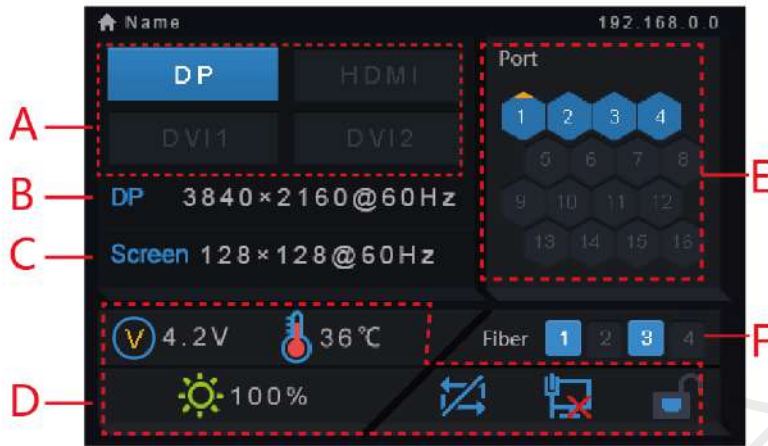

5 Home Screen

After the MCTRL4K is powered on, its home screen appears, as shown in [Figure 5-1](#).

Figure 5-1 Home screen



Area	Description:
A	<p>The access status of inputs:</p> <ul style="list-style-type: none"> • On: Input available • Off: Input unavailable <p>The interval between unplugging and plugging the DP input must be greater than 5s. Otherwise, the DP input cannot be detected.</p>
B	<p>Display the current input information, including input type, resolution and frame rate.</p> <p>In multi-card mode, both DVI1 and DVI2 have inputs. The information about the two DVI inputs will be displayed alternately.</p>
C	<p>Display the resolution and frame rate of the currently configured LED display.</p>
D	 The supply voltage of the motherboard
	 The temperature inside the chassis
	 The LED display brightness
	 The 3D function is enabled (This icon is not displayed when the function is disabled).
	 Genlock is connected (This icon is not displayed when Genlock is not connected).
	 Current status of DVI1 and DVI2 inputs: Not in sync/In sync
	 The connection status of control ports: USB connected/Ethernet connected/Not connected
 Front panel buttons unlocked/locked <ul style="list-style-type: none"> • Hold down the knob and BACK button simultaneously for 5s or longer to lock or unlock the buttons. • After the buttons are locked, all the button operations will not take effect and  appears on the home screen. 	

Area	Description:
E	<p>The working status of the Ethernet ports</p> <ul style="list-style-type: none"> • Always on: The Ethernet port connection works and the port serves as primary. • Off: The Ethernet port is not connected or the connection does not work. • Always on and a mark (not flashing) on top corner of icon: The Ethernet port is in redundancy status, but the redundancy has not taken effect. • Always on and a mark (flashing) on top corner of icon: The Ethernet port is in redundancy status and the redundancy has taken effect.
F	<p>OPT1/OPT2: Primary optical ports OPT1 corresponds to Ethernet ports 1 to 8 and OPT2 corresponds to Ethernet ports 9 to 16. Their statuses are as below.</p> <ul style="list-style-type: none"> • Always on: The optical port connection works and the port serves as primary. • Off: The optical port is not connected or the connection does not work. <p>OPT3/OPT4: Backup optical ports OPT3 is the backup of OPT1, and OPT4 is the backup of OPT2. Their statuses are as below.</p> <ul style="list-style-type: none"> • Off: The optical port is not connected or the connection does not work. • Always on: The optical port connection works, but the redundancy has not taken effect. • Always on and a mark on top corner of icon: The optical port connection works and the redundancy has taken effect.

6 Menu Operations

The MCTRL4K is powerful and easy to use. You can quickly configure the LED screen to light it up and display the entire input source following the steps in 6.1 Quick Screen Configuration. With other menu settings, you can further improve the LED screen display effect.

6.1 Quick Screen Configuration

Following the three steps below, namely Set Input Mode > Set Input Resolution > Quickly Configure the Screen, you can quickly light up the LED screen to display the entire input source.

6.1.1 Step 1: Set Input Mode

The input mode settings include DVI mode, input source, mosaic mode, and limited to full settings.

Figure 6-1 Input mode settings

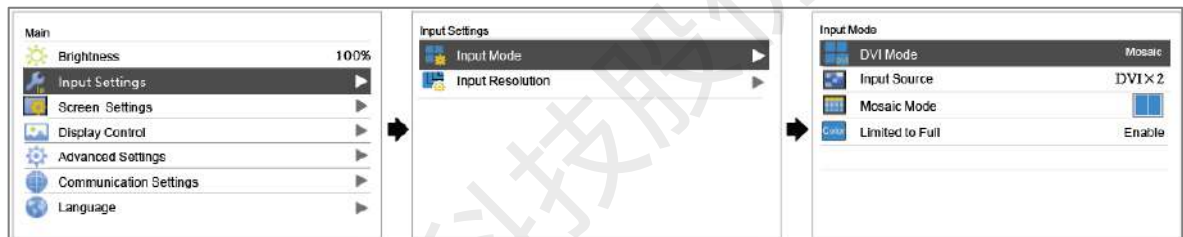

Step 1 Set the DVI mode. Options include **Mosaic** and **Multi-card**.

Step 2 Select an input source. Different DVI modes support different input sources.

- In mosaic mode, the input source can be **Auto**, **DP**, **HDMI** or **DVI x 2**.

When the input source is **Auto**, the device will detect the inputs automatically in the order of DP > HDMI > DVI.

- In multi-card mode, the input sources can be **DVI 1** and **DVI 2**.

The MCTRL4K works as two independent sending cards and the loading capacity of each card is up to 3840×1080@60Hz. The images of both DVI 1 and DVI 2 input sources can be displayed on LED display simultaneously, but they cannot be set at the same time.

Step 3 (Optional) In mosaic mode, set the DVI mosaic mode. The mosaic mode can be **Top and Bottom** or **Side by Side**.

Step 4 Enable **Limited to Full** for the input source.

The input source color range includes RGB Full and RGB Limited. This function automatically converts the color range of the input source from RGB Limited to RGB Full, allowing for more accurate video processing.

- Disable: Do not convert RGB Limited to RGB Full.

- Enable: Convert RGB Limited to RGB Full. You are advised to enable this function when the input source has a limited color range.

Note:

You can enable the Limited to Full function only when the input source is RGB limited. When the input source is RGB full, enabling this function will cause grayscale loss.

6.1.2 Step 2: Set Input Resolution

The input resolution can be set through either of the following methods.

Method 1: Select a Preset Resolution

Select the target resolution from the standard resolution presets.

Input Source	Available Standard Resolution Presets
DL-DVI	1280×1024@(24/25/30/48/50/60/72/75/85/100/120)Hz 1366×768@(24/25/30/48/50/60/72/75/85/100/120)Hz 1440×900@(24/25/30/48/50/60/72/75/85/100/120)Hz 1600×1200@(24/25/30/48/50/60/72/75/85/100/120)Hz 1920×1080@(24/25/30/48/50/60/72/75/85/100/120)Hz 1920×1200@(24/25/30/48/50/60/72/75/85/100)Hz 1920×2160@(24/25/30/48/50/60)Hz 2560×1600@(24/25/30/48/50/60)Hz 3840×1080@(24/25/30/48/50/60)Hz 3840×2160@(24/25/30)Hz
HDMI	1280×1024@(24/25/30/48/50/60/72/75/85/100/120)Hz 1440×900@(24/25/30/48/50/60/72/75/85/100/120)Hz 1600×1200@(24/25/30/48/50/60/72/75/85/100/120)Hz 1920×1080@(24/25/30/48/50/60/72/75/85/100/120)Hz 1920×1200@(24/25/30/48/50/60/72/75/85/100/120)Hz 1920×2160@(24/25/30/48/50/60/72/75/85/100/120)Hz 2048×1536@(24/25/30/48/50/60/72/75/85/100/120)Hz 2560×1600@(24/25/30/48/50/60/72/75/85/100/120)Hz 3840×1080@(24/25/30/48/50/60/72/75/85/100/120)Hz 3840×2160@(24/25/30/48/50/60)Hz
DP	1280×1024@(24/25/30/48/50/60/72/75/85/100/120)Hz 1366×768@(24/25/30/48/50/60/72/75/85/100/120)Hz 1440×900@(24/25/30/48/50/60/72/75/85/100/120)Hz

1600x1200@(24/25/30/48/50/60/72/75/85/100/120)Hz
1920x1080@(24/25/30/48/50/60/72/75/85/100/120)Hz
1920x1200@(24/25/30/48/50/60/72/75/85/100/120)Hz
1920x2160@(24/25/30/48/50/60/72/75/85/100/120)Hz
2560x1600@(24/25/30/48/50/60/72/75/85/100/120)Hz
3840x1080@(24/25/30/48/50/60/72/75/85/100/120)Hz
3840x2160@(24/25/30/48/50/60)Hz

Note

The MCTRL4K is adaptive to decimal frame rates (23.98/29.97/47.95/59.94/71.93/119.88 Hz).

Method 2: Customize a Resolution

Customize a resolution by setting a custom width, height and refresh rate.

- Step 1 On the home screen, press the knob to enter the main menu screen.
- Step 2 Choose **Input Settings > Input Resolution > Custom** and set the width, height and refresh rate.
- Step 3 Select **Apply** and press the knob to apply the custom resolution.

How to Set an Ultra-High Resolution

When the input source is DP or HDMI, you can set an ultra-high resolution via the NVIDIA graphics card of the computer. The width or height is up to 7680 pixels.

Recommended graphics cards: NVIDIA GeForce GTX 970, NVIDIA GeForce GTX 1060, and NVIDIA GeForce GTX 750 Ti

Note

When the width or height of the output image is greater than 4092 pixels, the resolution must be customized via the NVIDIA graphics card.

- Step 1 Right-click on desktop.
- Step 2 Select **NVIDIA Control Panel**.
- Step 3 On the left panel, choose **Display > Change resolution**. On the right area, select **NOVA MCTRL4K**.

Figure 6-2 Changing resolution

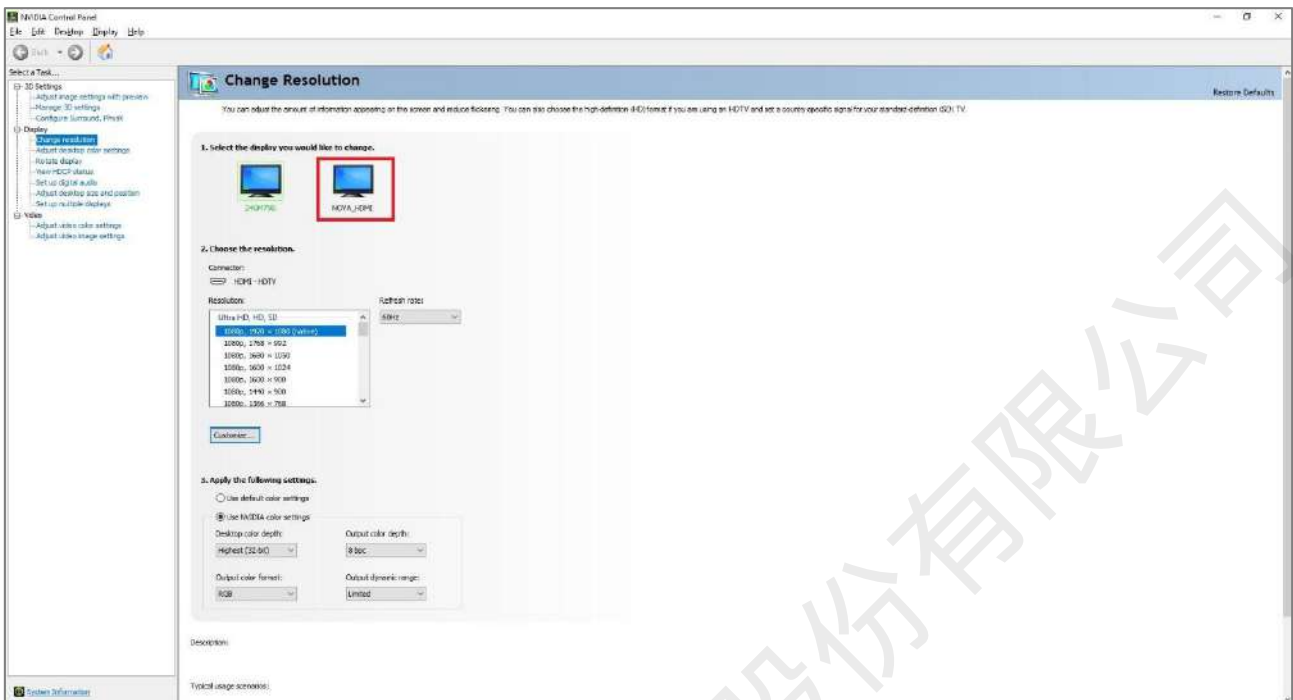

Step 4 Under **2. Apply the following settings**, click **Customize**. In the **Customize** dialog box that appears, click **Create Custom Resolution**. In the **Create Custom Resolution** dialog box that appears, set the parameters.

- When you set the timing standard to **Manual**, use the *MCTRL4K Ultra-High Resolution Settings Generator (Rev 1.1)* to calculate the parameters, including active pixels, front porch (pixels), sync width (pixels), polarity, total pixels and refresh rate. Then enter the parameter values manually. Note that the pixel clock must not be greater than 595.0 MHz.
- When you set the timing standard to **CVT reduced blank**, the software will calculate the parameters automatically and they cannot be changed manually.

Figure 6-3 Creating custom resolution

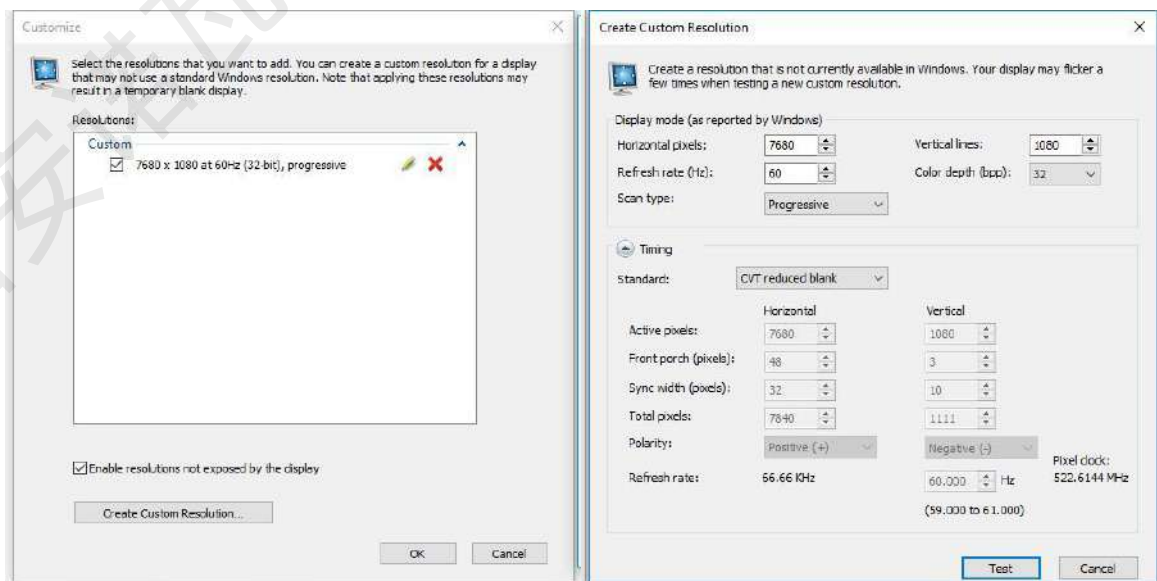

Step 5 Click **Test**. In the displayed dialog box indicating the test is successful, click **Yes** to save the custom resolution.

Figure 6-4 Applying changes

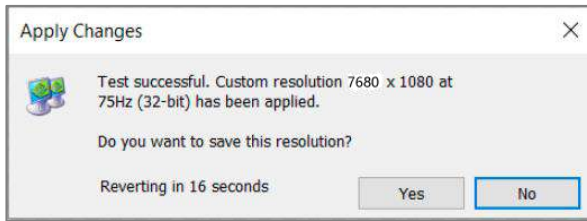

6.1.3 Step 3: Quickly Configure the Screen

Follow the steps below to complete quick screen configuration.

Step 1 On the home screen, press the knob to enter the main menu.

Step 2 Choose **Screen Settings > Quick Config** to enter its submenu and set the parameters.

- Set **Cabinet Row QTY** and **Cabinet Col QTY** (numbers of cabinet rows and columns to be loaded) according to the actual situation of the screen.
- Set **Port1 Cabinet QTY** (number of cabinets loaded by Ethernet port 1). The device has restrictions on the number of cabinets loaded by the Ethernet ports. For details, see Note a).
- Set **Data Flow (Front View)** of the screen. For details, see Note c), d), and e).

Figure 6-5 Quick configuration

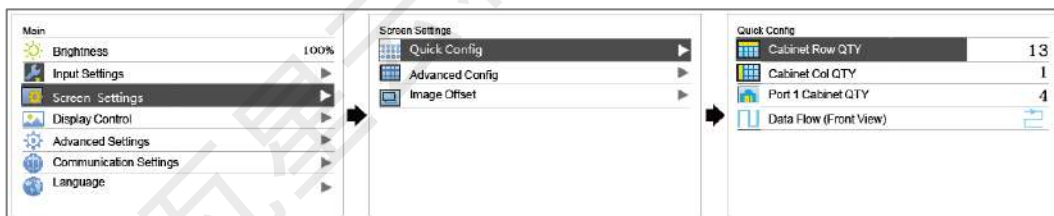

Note:

a). If n ports are used to load the screen, the number of cabinets loaded by each of the first $(n-1)$ ports must be the same and the integral multiple of the number of cabinet rows or columns, and it must be greater than or equal to the number of cabinets loaded by the last port.

Example:

If all the 16 Ethernet ports are used to load the screen, the number of cabinets loaded by ports 1–15 must be the same and the integral multiple of the number of cabinet rows or columns. Therefore, you need to set only the number of cabinets loaded by port 1 according to the actual situation. The number of cabinets loaded by port 16 must be less than or equal to the number of cabinets loaded by port 1.

b). For irregular screens, NovaLCT software must be connected to configure the screen.

c). During data flow settings, you can rotate the knob to select a target data flow pattern.

- d). During data flow settings, ensure that the cabinets loaded by each Ethernet port are connected one by one in the same direction.
- e). During data flow settings, ensure that Ethernet port 1 is at the beginning position of the whole physical connection.

6.2 Brightness Adjustment

This function allows you to adjust the LED screen brightness in an eye-friendly way according to the current ambient brightness. Besides, appropriate screen brightness can extend the service life of the LED screen.

Figure 6-6 Brightness adjustment

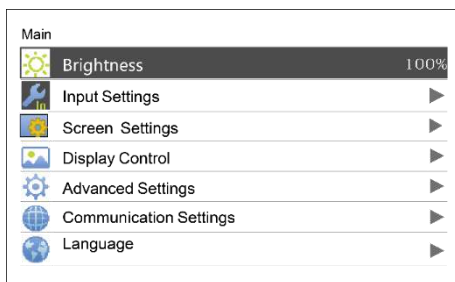

- Step 1 On the home screen, press the knob to enter the main menu screen.
- Step 2 Select **Brightness** and press the knob to confirm the selection.
- Step 3 Rotate the knob to adjust the brightness value. You can see the adjustment result on the LED screen in real time. Press the knob to apply the brightness you set when you are satisfied with it.

6.3 Screen Settings

Configure the LED screen to ensure the screen can display the entire input source normally.

Screen configuration methods include quick and advanced configurations. They have constraints:

- The two methods cannot be enabled at the same time.
- After the screen is configured in NovaLCT, do not use any of the two methods on the MCTRL4K to configure the screen again.

6.3.1 Advanced Configuration

Set parameters for each Ethernet port, including number of cabinet rows and columns (**Cabinet Row QTY** and **Cabinet Col QTY**), horizontal offset (**Start X**), vertical offset (**Start Y**), and data flow.

Figure 6-7 Advanced configuration

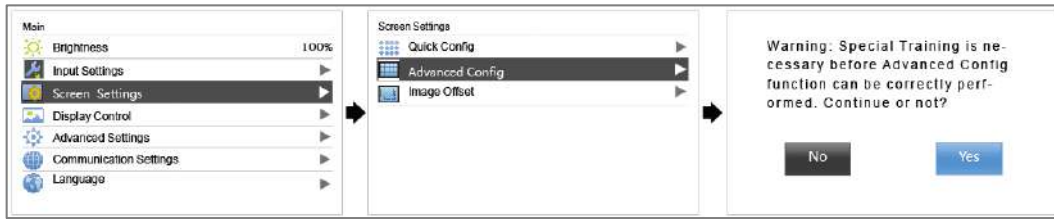

- Step 1 Choose **Screen Settings** > **Advanced Config** and press the knob.
- Step 2 In the caution dialog screen, select **Yes** to enter the advanced configuration screen.
- Step 3 Enable **Advanced Config**, select an Ethernet port, set the parameters for it, and apply the settings.
- Step 4 Select the next Ethernet port to continue setting until all the Ethernet ports are set.

6.3.2 Image Offset

After configuring the screen, adjust the horizontal and vertical offsets (**Start X** and **Start Y**) of the overall display image to ensure it is displayed in the desired position.

Figure 6-8 Image offset

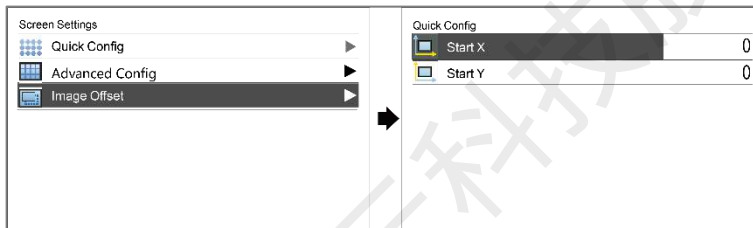

6.4 Display Control

Control the display status on the LED screen.

Figure 6-9 Display control

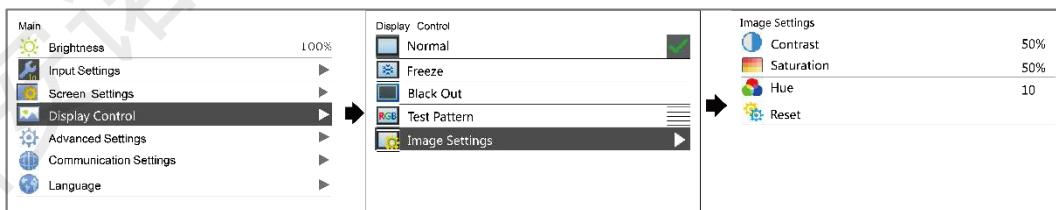

- Normal: Display the content of the current input source normally.
- Black Out: Make the LED screen go black and do not display the input source. The input source is still being played in the background.

- Freeze: Make the LED screen always display the frame when frozen. The input source is still being played in the background.
- Test Pattern: Test patterns are used to check the display effect and pixel operating status. There are 8 test patterns, including pure colors and line patterns.
- Image Settings: Adjust the contrast, saturation and hue of the output image to improve the display effect.

Parameter	Description
Contrast	Range: 0% to 100%; step: 1%
Saturation	Range: 0% to 100%; step: 1%
Hue	Range: -180 to +180; step: 1

Note

The image settings function is unavailable when the calibration function is enabled.

6.5 Advanced Settings

Figure 6-10 Advanced settings

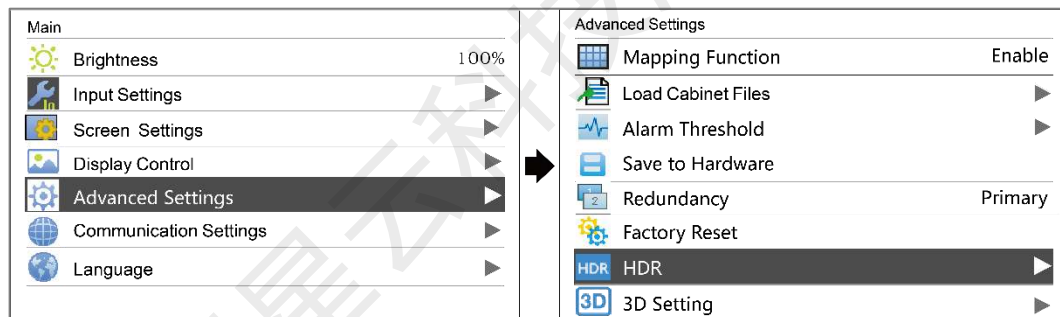

6.5.1 Mapping Function

When this function is enabled, each cabinet of the screen will display the sequence number of the cabinet and the Ethernet port that loads the cabinet.

Figure 6-11 Illustration of mapping function



Example: "P:01" stands for the Ethernet port number and "#001" stands for the cabinet number.

Note

The receiving cards used in the system must support the Mapping function.

6.5.2 Load Cabinet Configuration Files

Before you begin: Save the cabinet configuration file (*.rcfgx or *.rcfg) to the local PC.

Note: Configuration files of irregular cabinets are not supported.



- Step 1 Run NovaLCT and choose **Tools > Controller Cabinet Configuration File Import**.
- Step 2 On the displayed page, select the currently used Ethernet port, click **Add Configuration File** to select and add a cabinet configuration file.
- Step 3 Click **Save the Change to HW** to save the change to the controller.

Figure 6-12 Importing configuration file of controller cabinet



6.5.3 Set Alarm Thresholds

Set the alarm thresholds for device temperature and voltage. When a threshold is exceeded, its corresponding icon on the home screen will be flashing, instead of displaying the value.

-  : Voltage alarm. The voltage value is red and flashing. The threshold range is 3.5 V to 7.5 V.
-  : Temperature alarm. The temperature value is red and flashing. The threshold range is -20°C to $+85^{\circ}\text{C}$.

6.5.4 Save to Hardware

You can send and save the current screen configuration parameters to the receiving cards. The configuration data will not be lost after the device is powered off.

6.5.5 Redundancy Settings

You can set the MCTRL4K as the primary device or backup device.

- Set as Primary: The icon of the target Ethernet port on the home screen is highlighted.
- Set as Backup: The icon of the target Ethernet port on the home screen is highlighted and a small mark appears on the top corner of the icon.

When the primary device fails, the backup device will take over the work in real time, that is, the backup takes effect. After the backup takes effect, the target Ethernet port icons on the home screen will have marks on top flashing once every 1 second.

6.5.6 Factory Reset

Reset the controller parameters to factory settings.

6.5.7 HDR

HDR is the abbreviation for High-Dynamic Range. HDR function can greatly enhance the display image quality, allowing for a more clear and vivid image when the device is used together with NovaStar A8s or A10s Plus receiving cards.

The HDR supports HDR10 and HLG standards. You can use the following two methods to enable HDR function and set its parameters.

Method 1: In LCD Menu

Step 1 Choose **Advanced Settings** > **HDR** and enable HDR function.

Step 2 Select an HDR type from HDR10 and HLG.

- When the input source is HDR10, you can set **Screen Peak Luma**, **Ambient Light** and **Low Grayscale Mode** to adjust the display effect.

- When the input source is HLG, you can select one HLG mode from the 7 modes, namely HLG1 (300 nits) to HLG7 (1700 nits).

Standard	Parameter	Description
HDR10	Screen Peak Luma	Range: 100 to 10000; step: 10 Used to adjust the screen brightness during normal operation
	Ambient Light	Range: 0 to 30; step: 10 Used to display the brightness of ambient light radiated to the screen (You need to enter the brightness value after measuring.)
	Low Grayscale Mode	Range: 0 to 50; step: 1 Used to improve the image display effect. The bigger the value, the clearer the details in shadows.
HLG	HLG Mode	A total of 7 HLG modes supported, including HLG1 (300 nits), HLG2 (450 nits), HLG3 (600 nits), HLG4 (750 nits), HLG5 (1000 nits), HLG6 (1300 nits) and HLG7 (1700 nits) Used to adjust the image display effect. You can select a mode based on the actual screen peak Luma value. At the same time, you can try the adjacent HLG modes based on the on-site ambient light brightness to see their effects and select the best mode.

Step 3 (Optional) Choose **Reset** to reset the HDR settings to factory settings.

Figure 6-13 LCD Menu Operations - HDR10

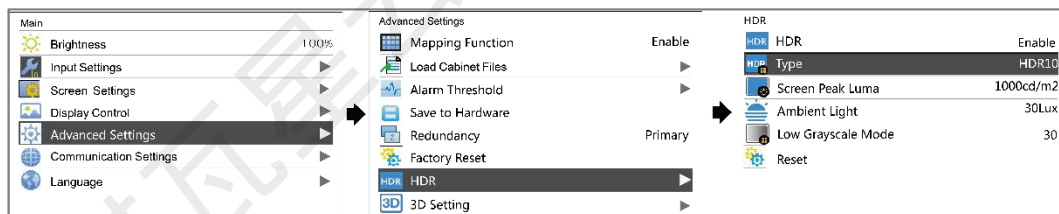
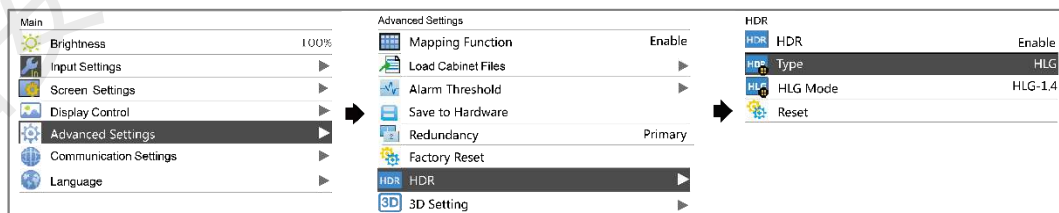

Figure 6-14 LCD Menu Operations - HLG



Method 2: In Software

Step 1 Run NovaLCT and choose **Settings > Adjust screen effect**.

Step 2 Under **HDR Parameter Settings**, select **Enable**.

Step 3 Click the drop-down box to select an HDR standard (HDR10 and HLG supported).

Step 4 Set the HDR parameters to adjust the display effect.

- When the input source is HDR10, you can drag the sliders to adjust the peak screen brightness, ambient light and low grayscale mode in real time.
- When the input source is HLG, you can click to select one HLG mode from the 7 modes, namely HLG1 (300 nits) to HLG7 (1700 nits).

Figure 6-15 Selecting Adjust screen effect

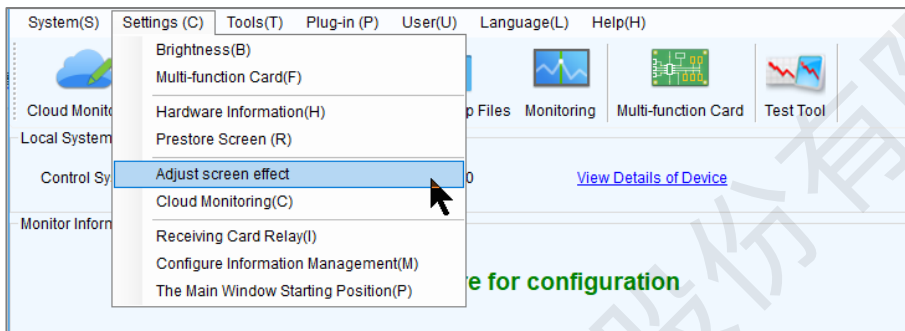
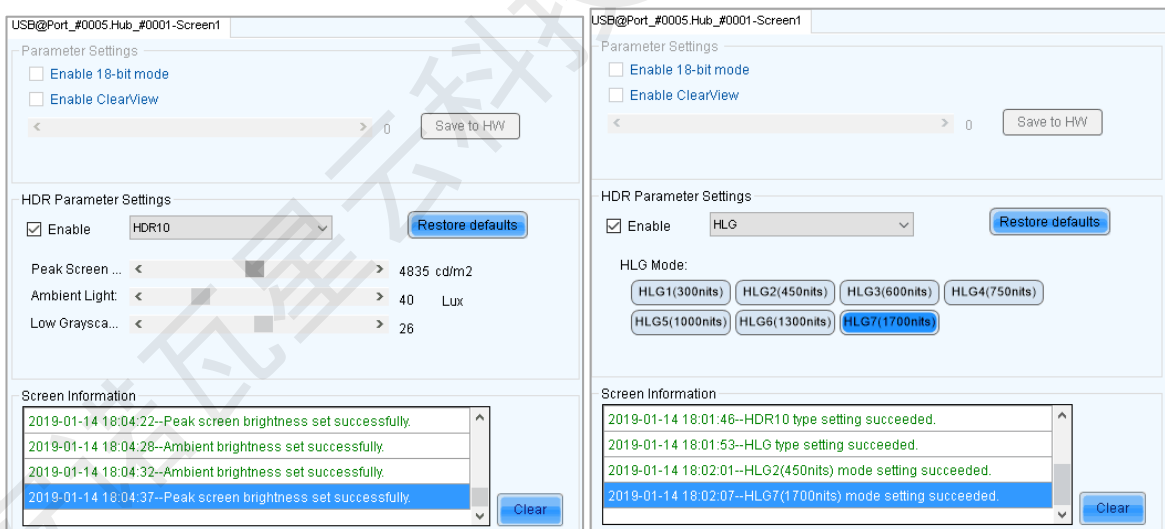
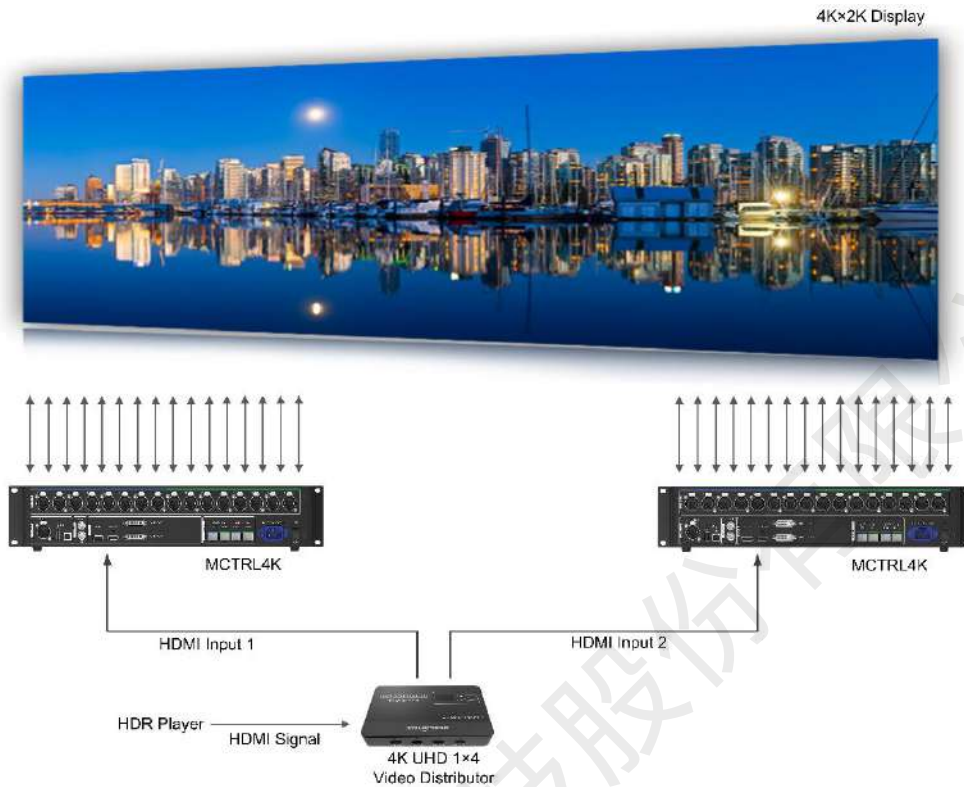

Figure 6-16 Adjusting screen effect



Applications



Note

- The HDR function supports only the HDMI input connector.
- The HDR function supports only the 10-bit input source.
- When the HDR function is enabled, any calibration operations cannot be performed.
- In NovaLCT, the HDR and ClearView functions cannot be enabled at the same time.
- Using the HDR function will reduce the loading capacity of the MCTRL4K by half because the HDR input source is 10-bit. Please refer to the diagram above and work out a connection solution in advance.
- After HDR is enabled, if the input source does not meet the requirements (10bit, HDR10/HLG), the HDR function will be automatically disabled. When the input source meets the requirements, the HDR function will be enabled automatically.

6.5.8 3D Settings

This function works with the 3D emitter EMT200 and 3D glasses to allow users to experience 3D display effects on LED screen. For detailed usage, see [3D Emitter EMT200 Quick Start Guide](#).

Applications

- Application 1: EMT200 connected behind the last receiving card

Figure 6-17 Application 1

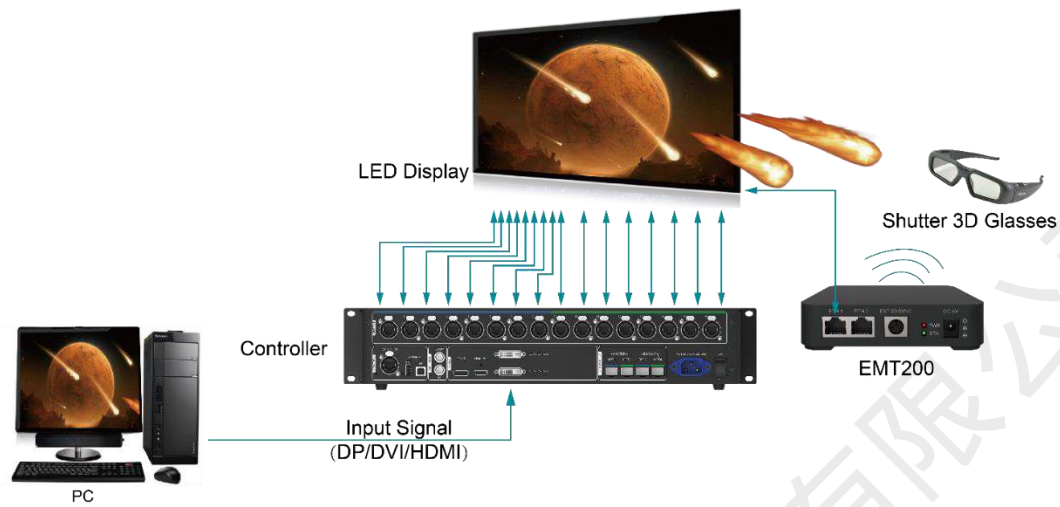

- Application 2: EMT200 connected between the controller and receiving card

Figure 6-18 Application 2

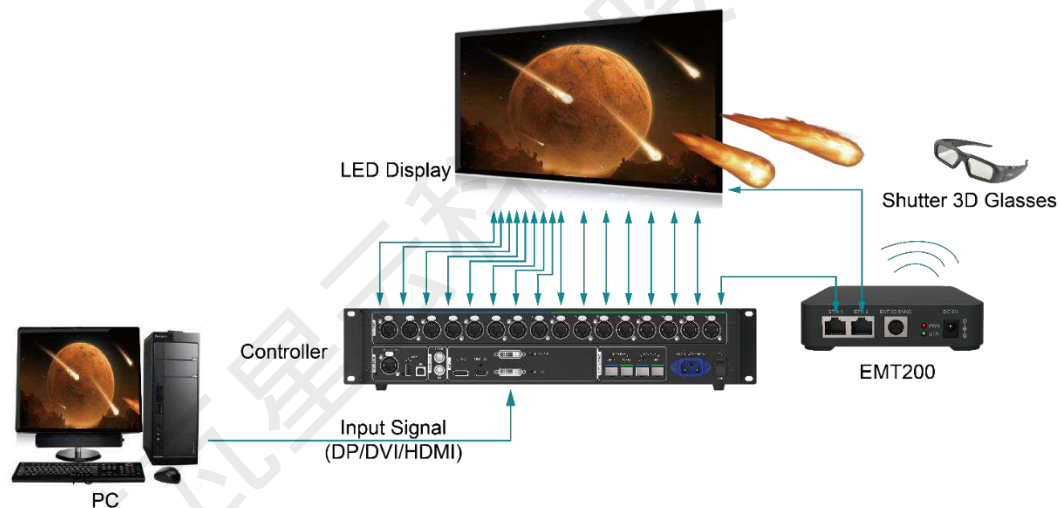

3D Setting Procedure

Step 1 Connect hardware devices according to the corresponding application.

Step 2 Enable 3D function by using any of the following methods and set 3D parameters.

- Method 1: In LCD menu
 1. On the home screen, press the knob to enter the main menu screen.
 - If the input source is DUAL DVI, go to 2.
 - If the input source is HDMI or DP, go to 4.
 2. Choose **Input Settings > Input Mode > DVI Mode > Mosaic**.

3. Press the **BACK** button to return to the main menu.
4. Choose **Advanced Settings > 3D Setting** to enter its submenu.
5. Enable 3D and set the video source format and eye priority mode.
 - **Video Source Format:** Set the format to **SBS** (side-by-side), **TAB** (top-and-bottom) or **Frame SEQ** (frame sequential) according to the format of the accessed video source.
 - **Eye Priority Mode:** Set the mode to **Left Eye** or **Right Eye**, wear the 3D glasses to watch the display and adjust the mode based on the display effect.

Figure 6-19 3D settings in LCD menu

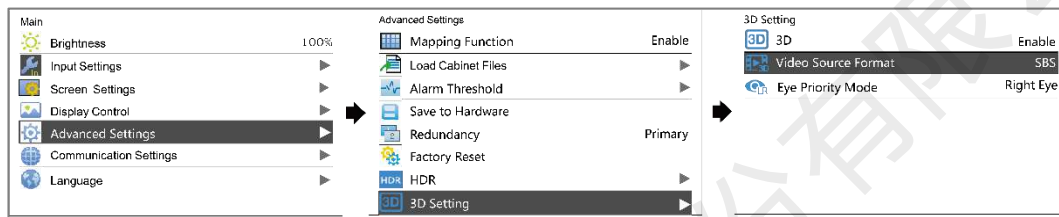

- Method 2: In software

1. Run NovaLCT, choose **Screen Configuration > Sending Card**, select **Enable** in the 3D function area and click **Settings** to enter the 3D parameter settings page.

Figure 6-20 Screen configuration





2. Set 3D function parameters. Then, click **Save to File** to save the parameters you set as a file. Or, you can click **Load from File** to load an existing 3D configuration file.

- **Mode Selection:** This parameter is available when the video source is Dual DVI, as shown in the figure below. It is unavailable when the video source is HDMI or DP.



- **Right Eye Start:** When you set the video source format to side-by-side or top-and-bottom, you must set the right eye start position.
- **Signal Delay Time:** When the input source is DP or HDMI, you must set this parameter. Please set this time as required to make sure that the left and right eye image switching of the 3D glasses is in sync with the image switching on the display.

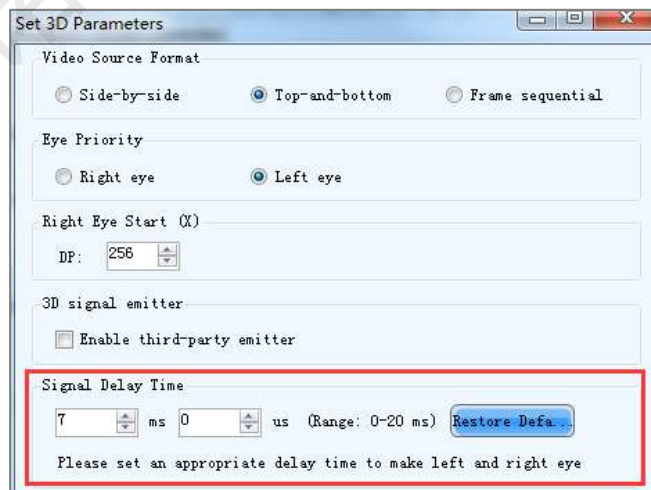

- On the screen configuration page, click **Save** to save current configuration parameters to the controller.

Note

- The 3D and low latency functions cannot be enabled at the same time.
- When the 3D function is enabled, any calibration operations cannot be performed.
- When the advanced screen configuration is enabled, 3D function is not supported.
- When the input source is DVI, DVI1 loads the images for left eye, and DVI2 loads the images for right eye. When the 3D function is in use, the input mode cannot be switched to multi-card mode.
- When the video source format is set to side-by-side or top-and-bottom, the frame rate of Ethernet output will be doubled (for example, if the frame rate of input source is 60 Hz, the frame rate of Ethernet output will be 120 Hz), and the loading capacity of Ethernet port will be reduced by half.

6.5.9 Genlock Setting

Set the Genlock phase offset to move the time of the sync source backward.

Figure 6-21 Genlock

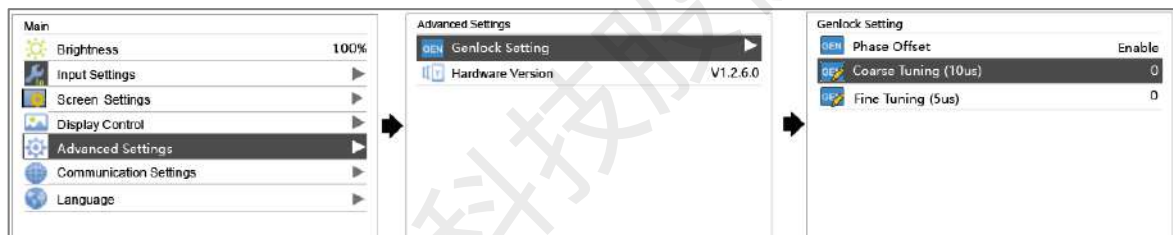

6.5.10 Hardware Version

Check the hardware version of the controller. If a new version is released, you can connect the controller to a PC to update the firmware programs in NovalCT.

6.6 Communication Settings

Set the communication mode and network parameters of the MCTRL4K.

Figure 6-22 Communication settings

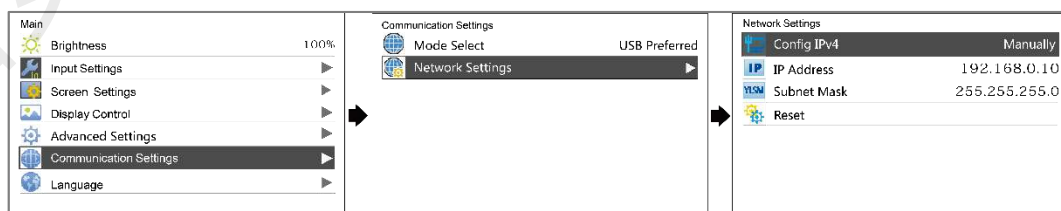

- Communication mode: Include USB preferred and Local Area Network (LAN) preferred.

The controller connects to PC via USB port and Ethernet port. If **USB Preferred** is selected, the PC prefers to communicate with the controller via the USB port, or else via the Ethernet port.

- The network settings can be done manually or automatically.
 - Manual settings include controller IP address and subnet mask.
 - Automatic settings can read the network parameters automatically.
- Reset: Reset the parameters to defaults.

6.7 Language

Change the system language of the device.

7 Operations on PC

7.1 Individual Gamma Adjustment for RGB

The MCTRL4K supports individual gamma adjustment for RGB when the bit depth of input source is 10-bit or 12-bit. This function can effectively control image non-uniformity in low grayscale conditions and white balance offset to improve image quality.

- Step 1 Run NovaLCT, click **Screen Configuration**, choose the current operation communication port and click **Next**.
- Step 2 On the **Sending Card** tab page, select the corresponding input source bit depth and click **Set**.
- Step 3 On the home page of NovaLCT, choose **Brightness > Manually Adjustment**.
- Step 4 Under **Advanced Settings**, choose **Gamma > Custom Gamma Adjustment** and click **Configuration** to enter the **Gamma Adjustment** page.
- Step 5 Adjust **Red Gamma**, **Green Gamma** and **Blue Gamma**.
- Step 6 Click **Send**.
- Step 7 Close the **Gamma Adjustment** page. On the **Brightness Adjustment** page, click **Save to HW**.

Figure 7-1 Gamma adjustment page

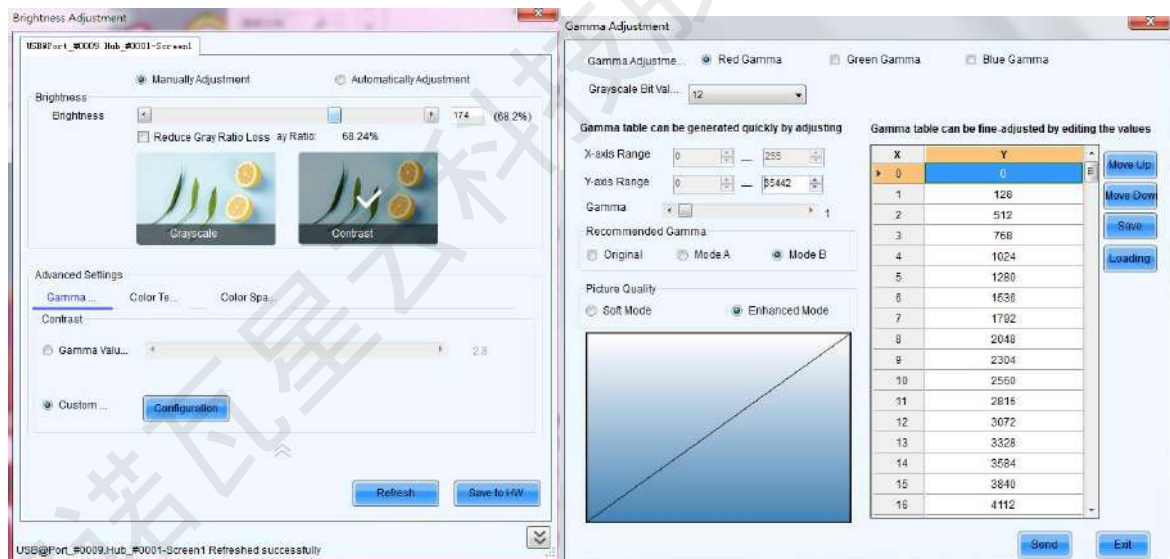

Note

When the bit depth of input source is 8-bit, the individual gamma adjustment for RGB is realized by the AXs (V2.0) series receiving cards.

7.2 Low Latency

The MCTRL4K supports a low latency of less than 1 ms (when the start position of image is 0). Low latency is used to reduce the time delay between the input of video signal to the controller and the corresponding output. To use the low latency function, you must ensure that each Ethernet port loads the cabinets vertically during screen configuration, as shown in [Figure 7-2](#).

Figure 7-2 Loading vertically

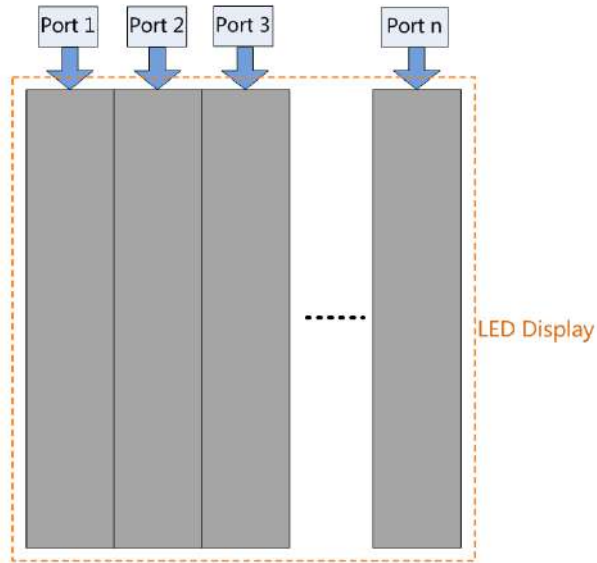

- Step 1 Run NovaLCT, choose **Screen Configuration** and enter the **Sending Card** tab page.
- Step 2 On the **Screen Configuration** page, select **Enable Low Latency**.
- Step 3 Click **Save System Configuration File** and **Save**.

Figure 7-3 Low latency



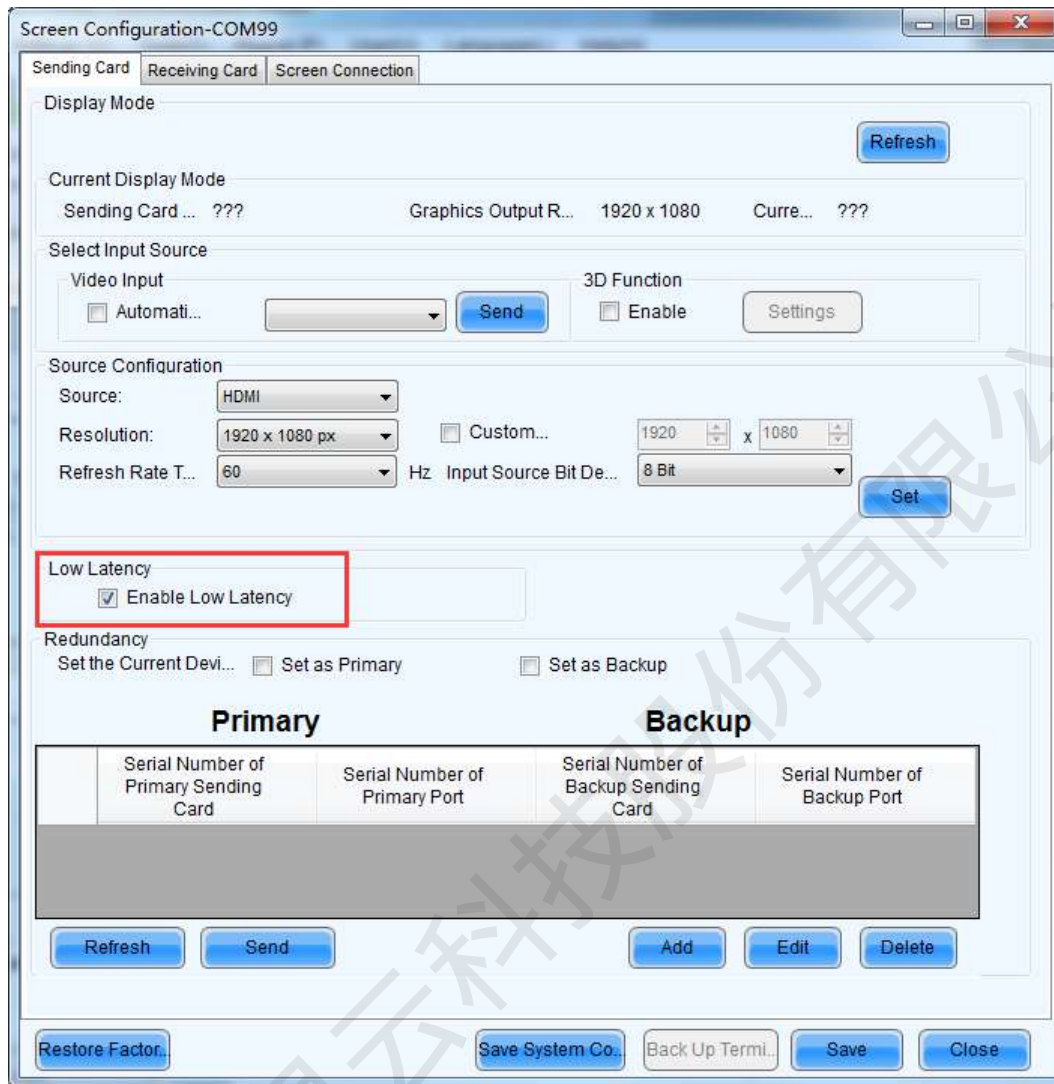

Note

- The low latency function is supported when the input source is DP or HDMI.
- The low latency and Genlock functions cannot be enabled at the same time.
- When the low latency function is enabled, the offset of image cannot exceed the size of input source.

7.3 Input Source Bit Depth

Set the bit depth of input source, including 8-bit, 10-bit and 12-bit.

- Step 1 Run NovaLCT, choose **Screen Configuration** and enter the **Sending Card** tab page.
- Step 2 Click the drop-down box next to **Input Source Bit Depth** and choose a bit depth.
- Step 3 Click **Save System Configuration File** and **Save**.

Figure 7-4 Input source bit depth

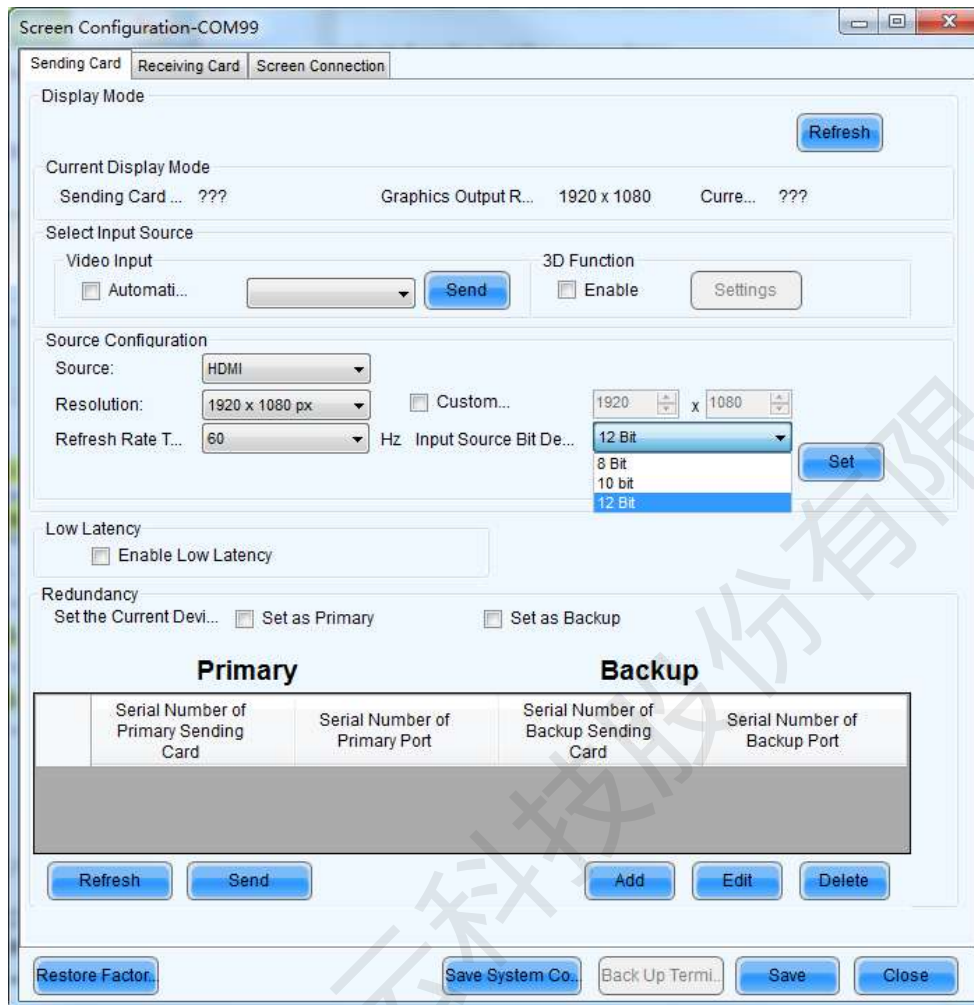

Table 7-1 Input source bit depth adjustment

Bit Depth	Description
8bit	The loading capacity of the MCTRL4K will not be reduced.
10bit	The loading capacity of the MCTRL4K will be reduced by half.
12bit	The loading capacity of the MCTRL4K will be reduced by half.

7.4 Operations on Web Page

The MCTRL4K supports web control functions, so the screen configurations can be easily and quickly performed on a PC or mobile device.

Note

For LED screen configuration on web, the Google Chrome browser (Chrome 50 or later) is recommended.

7.4.1 Environment Configuration

Figure 7-5 Environment configuration diagram

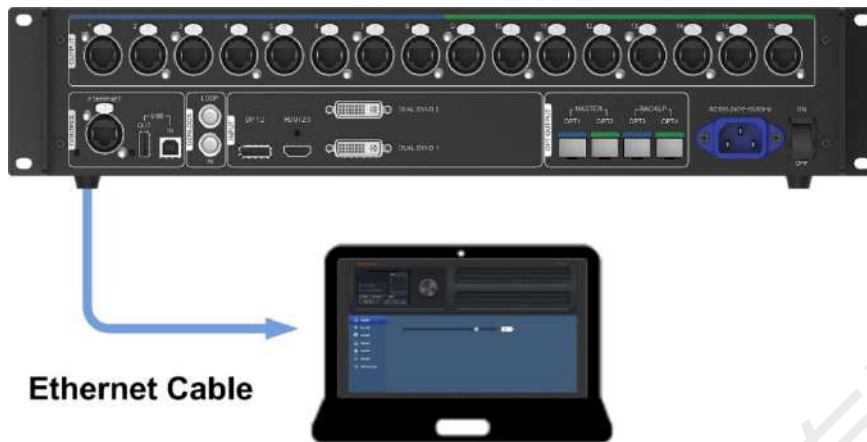

- Step 1 Connect the MCTRL4K to a PC (or a mobile device) via Ethernet cable or router.
- Step 2 Obtain the IP address of the MCTRL4K from the top-right corner of home screen.
- Step 3 Open the suggested web browser on your computer, enter "http//the above device IP address" in the address bar, and then press **Enter** to jump to the Web Control page for the device.

Note

The MCTRL4K and PC (or mobile device) must be on the same LAN.

7.4.2 Operations

Figure 7-6 Web control page



Area A: Hardware connection statuses and loading capacities of the input, output and other connectors on the MCTRL4K. For details, see chapter 5 [Home Screen](#).

Area B: Operations can be done in this area. For details, see chapter 6 [Menu Operations](#).

Click the menu bar on the left of area B to select the option to be adjusted, and the corresponding operations can be done on the right.

7.5 Software Operations on PC

7.5.1 NovaLCT

Connect the MCTRL4K to the control computer installed with NovaLCT V5.2.0 or later via USB port to perform screen configuration, brightness adjustment, calibration, display control, monitoring, etc. For details on their operations, see [NovaLCT LED Configuration Tool for Synchronous Control System User Manual](#).

Figure 7-7 NovaLCT



7.5.2 SmartLCT

Connect the MCTRL4K to the control computer installed with SmartLCT V3.4.0 or later via USB port to perform building-block screen configuration, seam brightness adjustment, real-time monitoring, brightness adjustment, hot backup, etc. For details on their operations, see the SmartLCT user manual.

Figure 7-8 SmartLCT



7.6 Firmware Update



7.6.1 NovaLCT

In NovaLCT, perform the following steps to update the firmware.

- Step 1 Run the NovaLCT. On the menu bar, go to **User > Advanced Synchronous System User Login**. Enter the password and click **Login**.
- Step 2 Type the secret code “**admin**” to open the program loading page.
- Step 3 Click **Browse**, select a program package, and click **Update**.

7.6.2 SmartLCT

In SmartLCT, perform the following steps to update the firmware.

- Step 1 Run SmartLCT and enter the V-Sender page.
- Step 2 In the properties area on the right, click  to enter the **Firmware Upgrade** page.
- Step 3 Click  to select the update program path.
- Step 4 Click **Update**.

8 Specifications

Electrical Parameters	Input voltage	AC 100 V~240 V-50/60 Hz
	Rated power consumption	30 W
Operating Environment	Temperature	-20°C to +60°C
	Humidity	10% RH to 90% RH, non-condensing
Storage Environment	Temperature	-20°C to +70°C
	Humidity	10% RH to 90% RH, non-condensing
Physical Specifications	Dimensions	482.6 mm × 372.0 mm × 88.1 mm
	Weight	4.6 kg
Packing Information	Carrying case	530 mm × 420 mm × 193 mm
	Accessory box	405 mm × 290 mm × 48 mm Accessories: <ul style="list-style-type: none"> • 1x power cord • 1x Ethernet cable • 1x USB cable • 1x HDMI cable • 1x DP cable
	Packing box	550 mm × 440 mm × 210 mm

Copyright © 2022 Xi'an NovaStar Tech Co., Ltd. All Rights Reserved.

No part of this document may be copied, reproduced, extracted or transmitted in any form or by any means without the prior written consent of Xi'an NovaStar Tech Co., Ltd.

Trademark

NOVA STAR is a trademark of Xi'an NovaStar Tech Co., Ltd.

Statement

Thank you for choosing NovaStar's product. This document is intended to help you understand and use the product. For accuracy and reliability, NovaStar may make improvements and/or changes to this document at any time and without notice. If you experience any problems in use or have any suggestions, please contact us via the contact information given in this document. We will do our best to solve any issues, as well as evaluate and implement any suggestions.

Official website
www.novastar.tech

Technical support
support@novastar.tech